



**Putzmeister**



# Truck-mounted concrete pumps 53-6 | 54-5 | 56-5

First-class investment for ambitious targets



## Size and strength at its best

### Immense reach with manageable dimensions

To create great things, you need adequate resources for the implementation. For challenging projects in building and underground construction, the decision in favour of a 53-6, 54-5 or 56-5 therefore comes easy. Because the vertical reach of up to 56 m offers lots of radius and the proven high-performance pumps from Putzmeister provide ample output.



### Putzmeister Promise

The name Putzmeister stands for machines that you can work with extremely productively and more than just competitively. For this purpose, we provide you with exceptionally innovative technologies as well as maximum quality and an excellent service. We support you with total commitment around the globe and around the clock. For every Putzmeister employee is aware of the fact that important tasks lie ahead for your machine.

### Your Putzmeister Team



# The 54-5\* in profile

### Generous in terms of radius

Up to 53 or 56 m vertical reach can be fully utilized by the 5-arm boom in roll Z-folding. Whether in halls, under bridges or in multi-storey buildings – these machines do a good job everywhere.

### Space-saving when supporting

The 54-5 and 56-5 are fitted with the TRDI support system developed by Putzmeister. The telescopic support legs can be securely placed in very small spaces.

### High flexibility with the 53-6

The flexible six-arm boom shows its true size particularly for ceiling concreting. Increased reach at great heights makes working on these complex construction sites easier.

\* Since the only difference between the 53-6, 54-5 and 56-5 is the placing boom, the information here mostly relates to all machines. The differences are clearly identified or described.

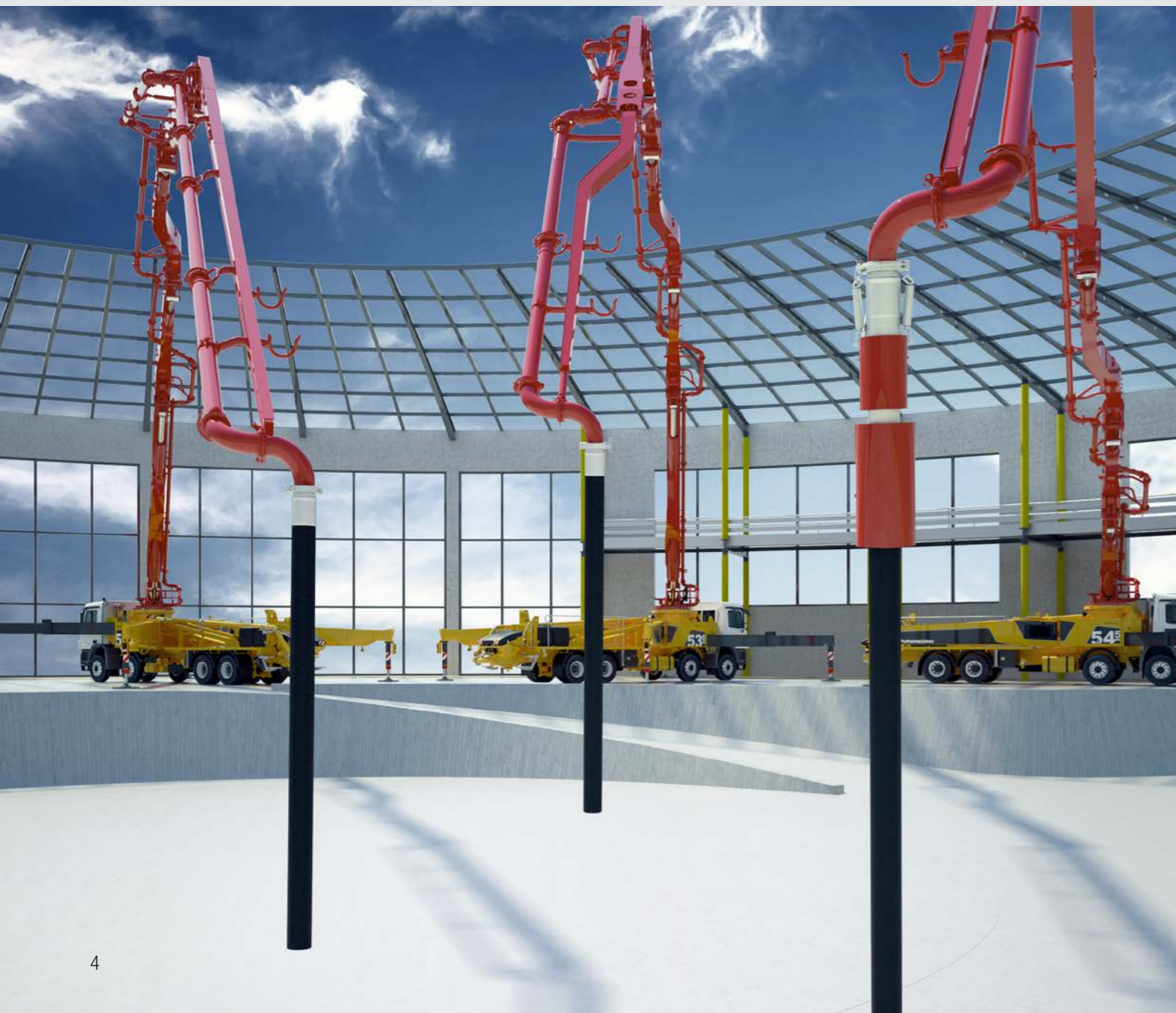

### Excellent handling

Thanks to elaborate ergonomics, the very good responsiveness of the boom control and place-saving support, the machines are pleasantly easy to operate.

### Exemplary in terms of safety

The broad consideration of all current standards and guidelines offers an outstandingly high level of safety. Thus, you always drive and work on the safe side.

### Economic in terms of time and costs

The optimised accessibility saves working time and thus money. The many maintenance-free components also ensure reduced costs. This means that these truck-mounted concrete pumps will pay off in a very short time and work with moderate operating costs throughout the entire service life.

Putzmeister Concrete Pumps GmbH | P.O. Box 2152 | 72629 Aichtal | Tel. +98 224 286 75-8 | Fax +98 224 228 78 | +98 0912 8 584 584 kormit.abedi@yahoo.com Right to make amendments reserved | © by Putzmeister | All rights reserved | Printed in Germany | 1707 [www.saghargostar-co.ir](http://www.saghargostar-co.ir)



# Great technology in action

## As versatile as your requirements – 53-6, 54-5 and 56-5

High reach, low support dimensions and a compact design are the best requirements to convince in daily operation. Additionally, our concrete pumps provide plenty of performance for efficient work, and with their coordinated geometry, are suitable for all common types of concrete. Depending on the country-specific licensing regulations, you will receive both models on 4 or 5 axles.



High level of production readiness: thanks to long service lives of the high-grade components used, e.g. chromium-plated delivery cylinder. Can also be extended as an option e.g. carbide wear parts kit.

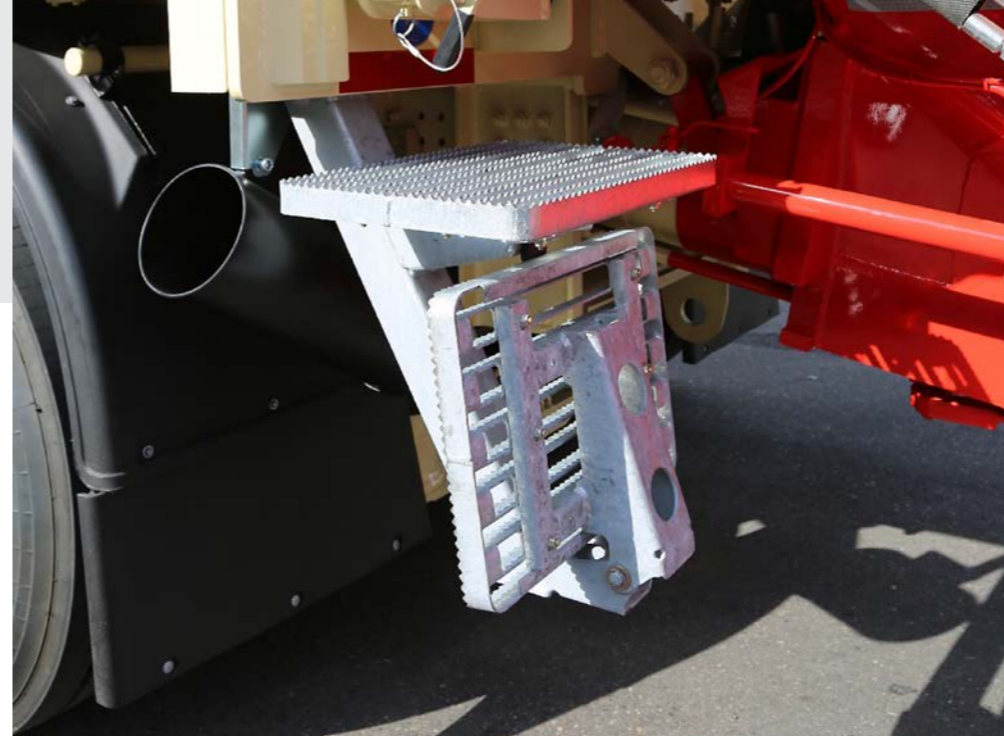

Collapsible steps, ideal protection against damage

Benefits are best demonstrated in the application

- **Smooth 5/6-arm placing boom** thanks to intelligent laying of the delivery line and the balanced development of the steel structure
- **Efficient work** through consistently clever ergonomic design
- **Maximum safety** thanks to closer consideration of current standards and guidelines
- **Service-friendly** as a result of optimised accessibility
- **Minimum service costs** thanks to maintenance-free components

**Putzmeister Concrete Pumps GmbH** | P.O. Box 2152 | 72629 Aichtal | Tel. +98 224 286 75-8 | Fax +98 224 228 78 | +98 0912 8 584 584 kormit.abedi@yahoo.com  
 Right to make amendments reserved | © by Putzmeister | All rights reserved | Printed in Germany | 1707  
[www.saghargostar-co.ir](http://www.saghargostar-co.ir)

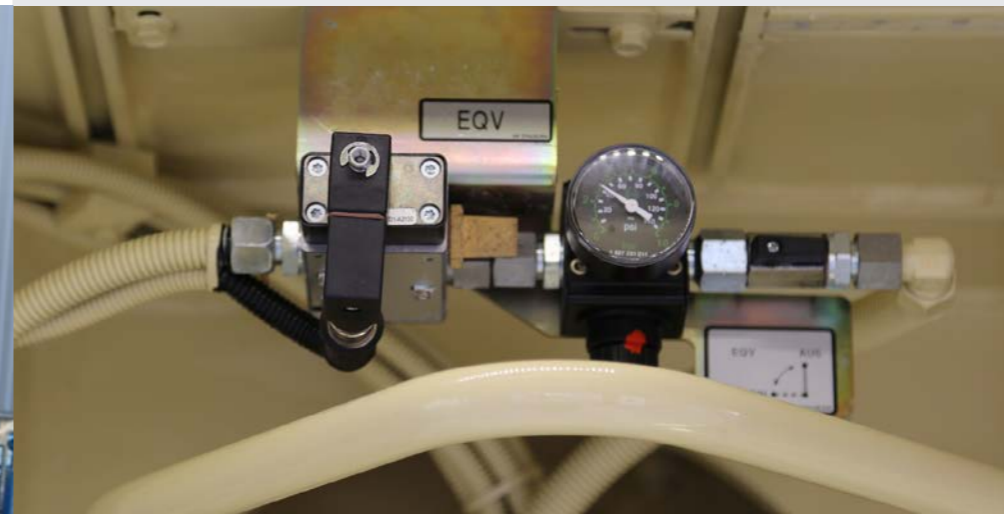

Clean: Optional EQV for clean movements of the end hose on site. No concrete drips out of the end hose.





# Putzmeister quality work in detail

## Our well thought-out concepts save you costs

How does it work? We develop solutions in the team that you can work with economically, safely and in an environmentally friendly manner. For example, the application of maintenance-free components, the automatic safety system ESC, the central grease lubrication system ...

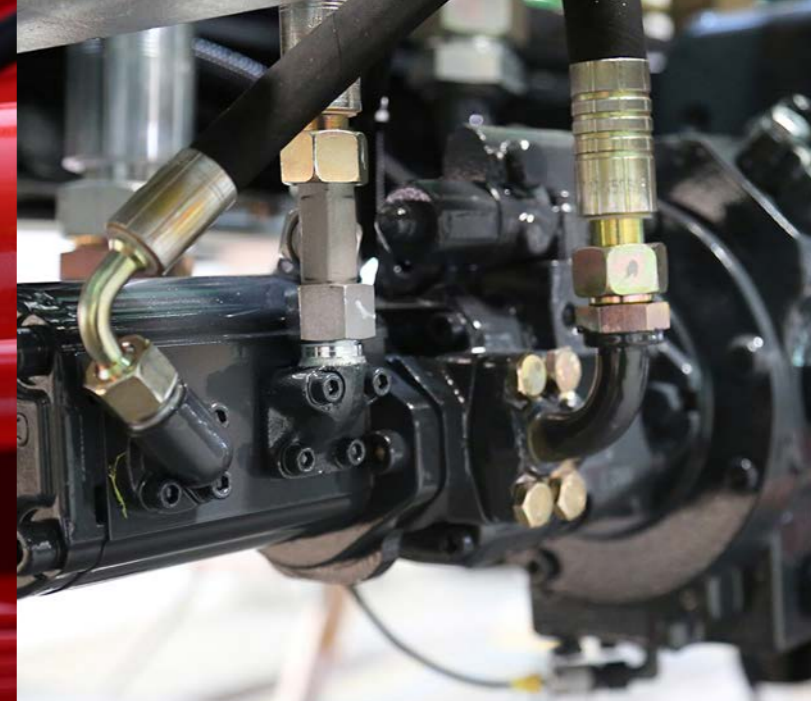

Maintenance-free components allow your operating and maintenance costs to be pleasantly low. For example, by wear-optimized 45° delivery line bends with long collars in every quality type for maximum service life of the delivery line.

Piston pumps with free flow hydraulics: In the closed loop the oil reaches the drive cylinder from the pump with minimal losses – for more power and considerably less oil consumption.



Innovation and quality only succeed with employees who think in a customer-oriented and future-oriented manner.



Automatic central grease lubrication system: The electrical central grease lubrication for the hopper ensures that the service life of the highly stressed components is maximized without any additional work.



High-output concrete pumps: Thanks to their coordinated geometry they are designed for all common types of concrete. Thus, more power is transferred and resources are saved.



Safety system ESC: The EN 12001:2012 requires absolute control over the interaction between support, boom and pump. ESC (Ergonic® Setup Control) allows you to work flexibly according to the standard.

Putzmeister Concrete Pumps GmbH | P.O. Box 2152 | 72629 Aichtal | Tel. +98 224 286 75-8 | Fax +98 224 228 78 | +98 0912 8 584 584  
kormit.abedi@yahoo.com Right to make amendments reserved | © by Putzmeister | All rights reserved | Printed in Germany | 1707  
www.saghargostar-co.ir

Putzmeister Concrete Pumps GmbH | P.O. Box 2152 | 72629 Aichtal | Tel. +98 224 286 75-8 | Fax +98 224 228 78 | +98 0912 8 584 584  
kormit.abedi@yahoo.com Right to make amendments reserved | © by Putzmeister | All rights reserved | Printed in Germany | 1707  
www.saghargostar-co.ir



# Long-lasting performance stroke for stroke

## Pump, drive, control geared to performance

Our concrete pumps have an optimally coordinated geometry for all common types of concrete. The long-lasting S-tube switch and the closed loop of the free flow hydraulics contribute significantly to high performance with minimum resource consumption. Just like the computer-based control EPS (Ergonic® Pump System).

**ergonic**  
inside®

### The S-tube keeps even rough mixes flowing

- The S-tube switch works smoothly and fast even with stiff, wear-intensive and coarse-grained mixes
- Long service life and service intervals, high machine availability
- Prolongation of the service life by the welding of a wear layer
- Easy replacement of the slide valve
- Optimized switching and less vibrations on the machine and boom



### EPS Control (Ergonic® Pump System)

EPS controls the operation of the concrete pump, motor and the placing boom fully electronically. What this means for you:

- High machine availability thanks to high-grade components with low wear
- Optimized, smooth pumping
- Reduced vibrations of machine and boom
- With EOC (Ergonic® Output Control), ideal engine speed for the lowest fuel consumption, wear and noise
- Fault management by means of EGD (Ergonic® Graphic Display)

### Opt for performance

With the 53-6, 54-5 or 56-5 you have different pumps at your disposal with 85 bar pumping output each: the relatively cheaper 16 H with two chromium-plated delivery cylinders Ø 230 mm and 108 m³/h pumping output as well as the smoother 16 H LS with Ø 250 mm and 160 m³/h pumping output. The LS works with a lower number of strokes and scores points with a higher service life.



### The pump at a glance

- **Service-friendly control system** with free flow hydraulics and thus consistently high oil quality
- **Particularly wear-resistant** design of S-tube switch, which guarantees long service life
- **Robust hopper** (bolted grille, optimized shape and optimized S-tube storage)
- **Agitator safety shutdown** via RFID (Radio Frequency Identification), including start-up protection
- **Maximum smooth pumping** with EPS and EOC, protects the pump and the vehicle
- **Avoidance of wear-intensive pressure peaks** thanks to smooth switchover with SN control and Push Over
- **Minimum operating costs** thanks to maintenance-free components and good accessibility
- **Simple replacement of components** through bolted concept

Putzmeister Concrete Pumps GmbH |  
P.O. Box 2152 | 72629 Aichtal | Tel. +98  
224 286 75-8 | Fax +98 224 228 78 | +98  
0912 8 584 584  
kormit.abedi@yahoo.com Right to  
make amendments reserved | © by  
Putzmeister | All rights reserved |  
Printed in Germany | 1707  
www.saghargostar-co.ir



# Considerable added value for machinists

## Workplace with maximum flexibility and comfort

If not only the output is right but the handling as well, then working becomes efficiency. The 53-6, 54-5 and 56-5 play right into your hands. Furthermore, when it comes to safety, maintenance and service they show their most user-friendly side. Whether agitator safety cutout via RFID, optimised accessibility or automatic central grease lubrication system – these machines support you noticeably in your daily work.

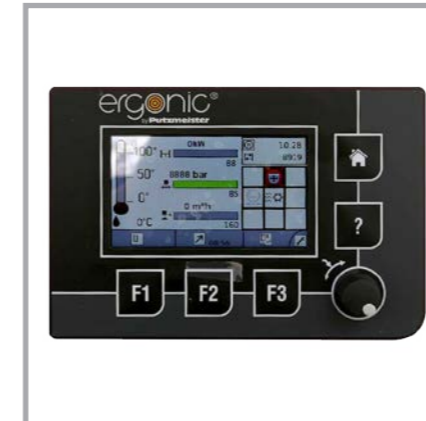

### New on-site operation brings light into the darkness\*

All displays and setting options can be read optimally on the large, high-resolution display screen. The buttons are provided with symbols and illuminated with LED.

### 53-6 – Everything from a single source

All available machine information is displayed clearly on the radio remote control.

\* for 54-5 and 56-5



## Precision in any position

The well thought out laying of the delivery lines and the balanced development of the steel structure, as well as the direct response characteristics of the boom control ensure precise movements, particularly in confined spaces.

EBC (Ergonic® Boom Control) offers even more comfort through fully electronic control of the placing boom (optional):

- **Constant, smooth guidance of the end hose** thanks to integrated vibration damping
- **Move even more smoothly** using the joystick
- **More operational reliability** by setting arm positioning parameters in restricted areas

Putzmeister Concrete Pumps GmbH  
 | P.O. Box 2152 | 72629 Aichtal | Tel.  
 +98 224 286 75-8 | Fax +98 224 228  
 78 | +98 0912 8 584 584  
 kormit.abedi@yahoo.com Right to  
 make amendments reserved | © by  
 Putzmeister | All rights reserved |  
 Printed in Germany | 1707  
 www.saghargostar-co.ir

**Optimum accessibility to all important components:**  
 Simplifies maintenance and service work and thus saves time, money and nerves.



**Large water tank** saves you frequent refilling and thus working time. Furthermore, it offers plenty of reserve for cleaning work.



**Agitator safety shutdown via RFID** (Radio Frequency Identification): the detection system provides the help of electromagnetic waves, including start-up maximum safety for operators.



# Putzmeister makes know-how transparent

## Great reach in the broadest sense

The 54-5 and 56-5 show their true colours at the operation site. Then the 5-arm placing boom in roll Z-folding displays its best (slip) properties.



## EBC – Productivity through vibration damping

The still end hose can be guided with one hand more easily and the concrete is inserted cleanly. The arm speed can be defined by each individual customer. In addition, the convenient folding and unfolding assistance with automatic boom cradle function is used to ensure the prevention of damage to the boom and truck.

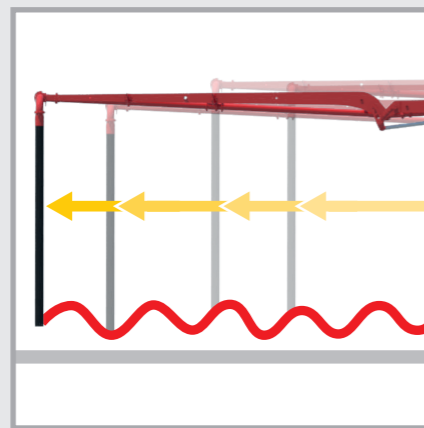

**ergonic**  
inside

**EBC:**  
EBC reduces the vertical movement of the boom to approx. one third and dampens the deflections of the end hose simultaneously in all directions.

## First compact – then great

The optimised kinematics of the 5-arm placing boom of the 54-5 and 56-5 ensures that maximum workspace is created and next to no “dead space” arises. The sixth arm on the 53-6 also offers even more application possibilities at a height of 53 m.

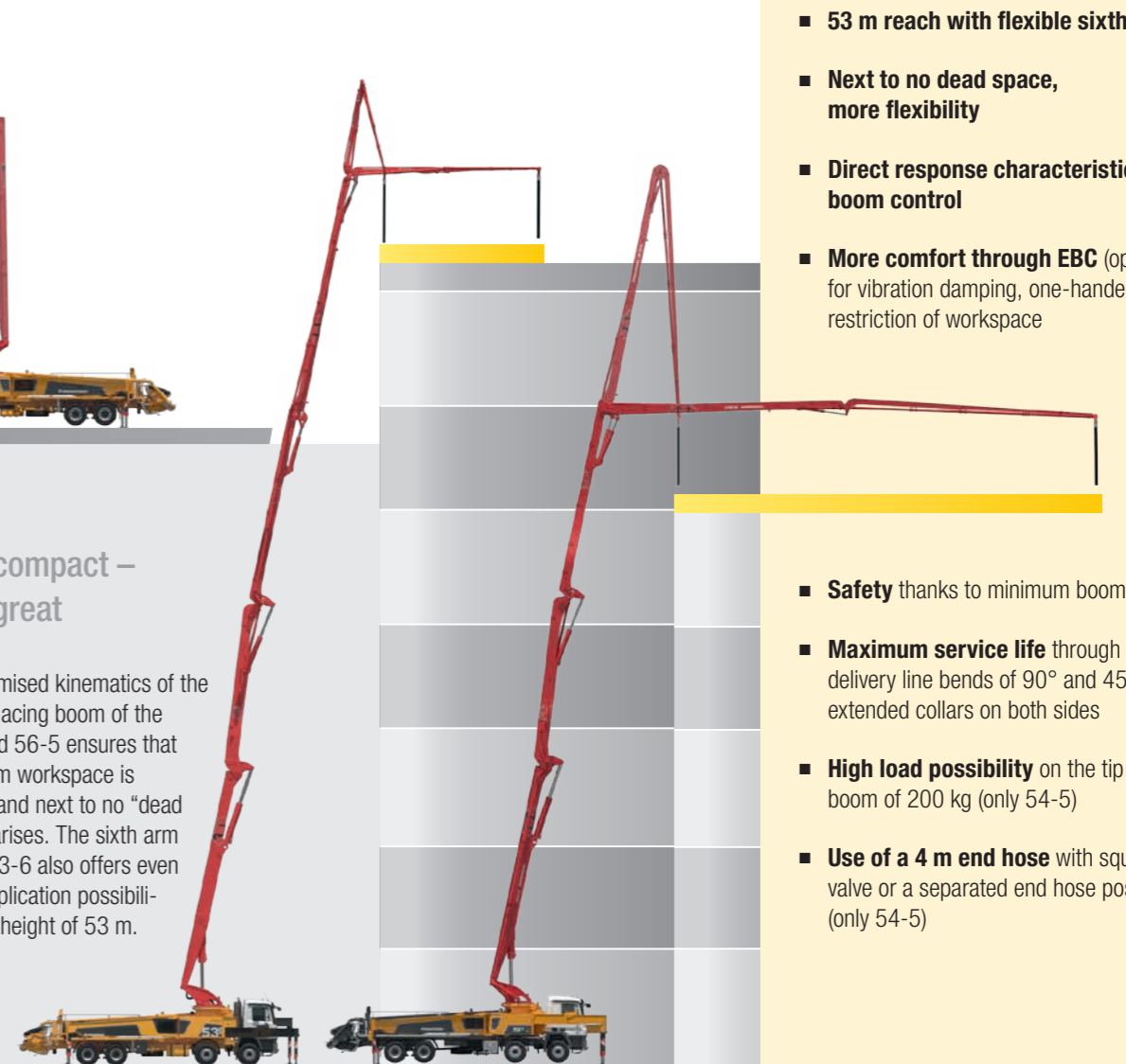

## The boom at a glance

- Around 54 or 56 m vertical reach with 5 arms in roll Z-folding
- 53 m reach with flexible sixth arm
- Next to no dead space, more flexibility
- Direct response characteristics of the boom control
- More comfort through EBC (optional) for vibration damping, one-handed control, restriction of workspace
- Safety thanks to minimum boom vibrations
- Maximum service life through Standard delivery line bends of 90° and 45° with extended collars on both sides
- High load possibility on the tip of the boom of 200 kg (only 54-5)
- Use of a 4 m end hose with squeeze valve or a separated end hose possible (only 54-5)

## One side gauge only when supporting

The optional OSS\* and ESC\*\* systems reduce the support width at maximum radius. Adjusting arm 1 to a vertical position extends the working range.

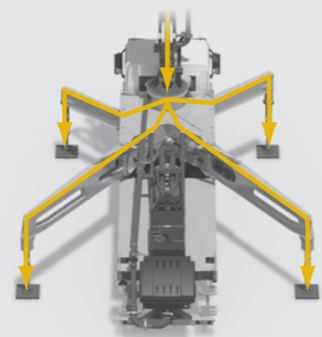

Force distribution with TRDI

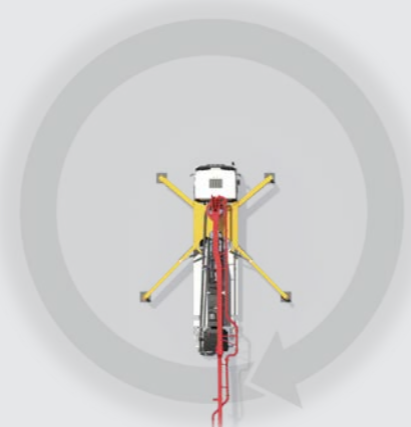

S support (standard)



LF/RF support (left frontal/right frontal)



Ls/Rs support (left one side/right one side)

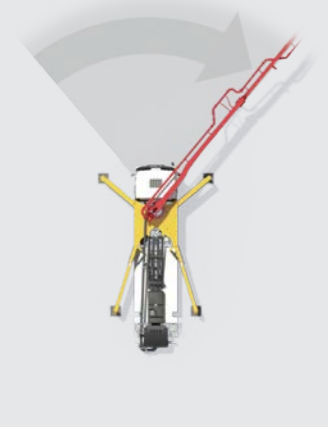

F support (frontal)

\* OSS (One Side Support) – assistance system for One Side Support. Availability depends on machine model.  
\*\* ESC – safety system for One Side Support (according to EN 12001:2012).



# 53-6, 54-5 and 56-5



Additionally, Emergency Stop on the left. The driver can react quickly, he does not have to run forward to the support foot control or run around the mixer.

## General

<b>Support width</b>	<b>front / rear</b>
<b>normal</b>	9.3m / approx. 12.1m
<b>OSS/ESC</b>	5.7m / approx. 8.3m
<b>Overall length</b>	approx. 14.1m
<b>Height</b>	under 4.0m

## Pumps

Type	Output m <sup>3</sup> /h	Pressure bar	Stroke mm	Cylinder Ø mm	Strokes/min
<b>16 H</b>	160*	85	2100	230	31
<b>16 H LS</b>	160*	85	2100	250	26

All data represents theoretical maximum values.  
\* rod side/piston side - max. output and max. concrete pressures cannot be operated at the same time.

## Placing boom

	56-5	54-5	53-6
<b>Folding type</b>	5-arm roll Z-folding (RZ)	5-arm roll Z-folding (RZ)	6-arm roll Z-folding (RZ)
<b>Vertical reach</b>	55.1 m	53.6 m	52.3 m
<b>Horizontal reach</b>	49.9 m gross	48.4 m gross	47.1 m gross
<b>Depth of reach</b>	40.3 m	39.8 m	37.4 m
<b>Unfolding height</b>	12.2 m	15.6 m	15.6 m
<b>End hose length</b>	max. 3 m	4 m	max. 3 m
<b>Delivery lines</b>	DN 125	DN 125	DN 125
<b>Slewing circle</b>	365°	365°	365°



Additional LED reversing light provides more safety by rear view.

## Equipment

With the Putzmeister 53-6, 54-5 or 56-5 we offer you a machine which already boasts substantial equipment as standard.

With the diverse optional equipment, you can also adapt your range of services to the needs and requirements of your customers.

- Ergonic® (EPS, EOC and EGD with fault management)
- Hopper grease lubrication system
- Radio remote control system with display and additional cable remote control
- Rotatable 45° delivery line bend with long collars
- Spacious platform
- Ergonomic work platform
- OSS (One Side Support) or ESC (Ergonic® Setup Control)
- Water tank with 800 l
- Agitator safety shutdown via RFID with start-up protection
- Connections for emergency supply
- Chromium-plated delivery cylinder
- Vibrator can be positioned as required thanks to the screwed-in grille
- EBC (Ergonic® Boom Control)
- Bypass filter for even better oil quality
- Wide range of lighting systems
- Foldable underrun protection with lighting
- Compressor

## 53-6

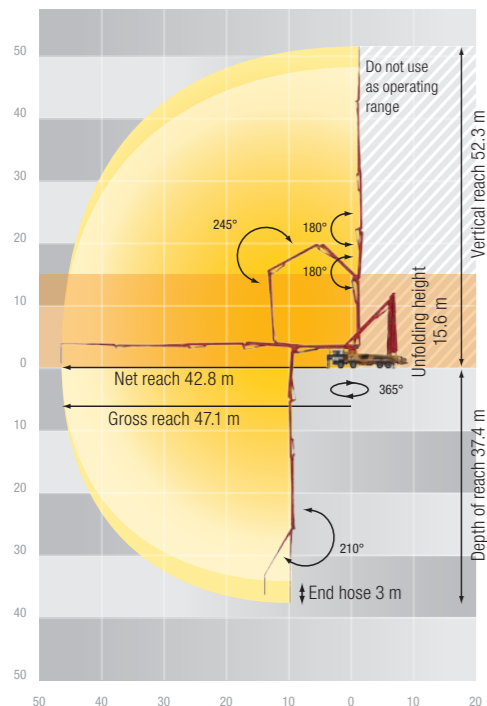

## 54-5

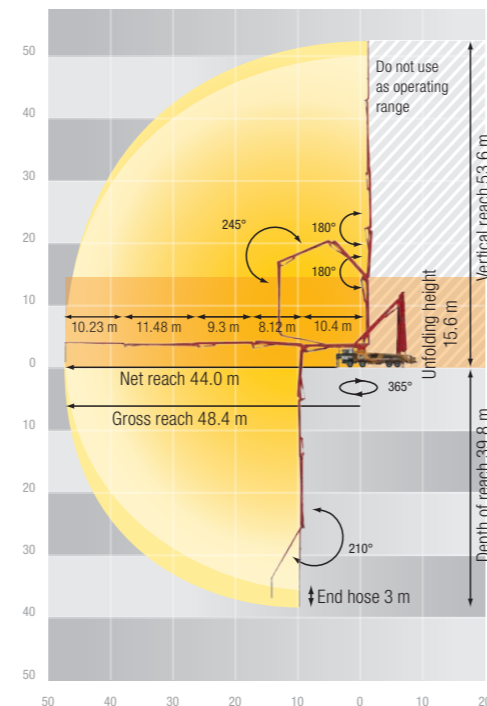

## 56-5

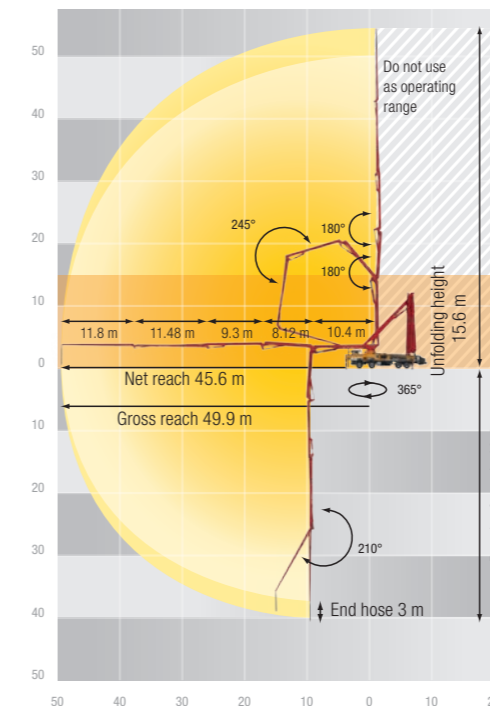

And much more ...

Standard  Optional



# Build on Putzmeister – in service, parts, training

## Everything that sets service apart

Swift assistance, meaningful advice and a reliable supply of genuine Putzmeister accessories and parts – in over 120 countries worldwide. This is what we at Putzmeister understand as first-class service.

### Ideally placed to support you

We provide continuous training for our service technicians, provide a close-knit information network and the latest equipment and consistently strive to meet our customers' needs.

Thanks to state-of-the-art technology, our employees have all the relevant technical information about your machine at their fingertips, should the need arise. Allowing us to provide you with the best possible support for emergencies, repairs or preventive maintenance.



## Genuine parts for maximum availability

It goes without saying that we use only genuine Putzmeister parts in our workshops. This is the only way to guarantee consistent quality, checked for interoperability. And you can be absolutely sure that your machine meets the tough requirements with maximum performance and availability.

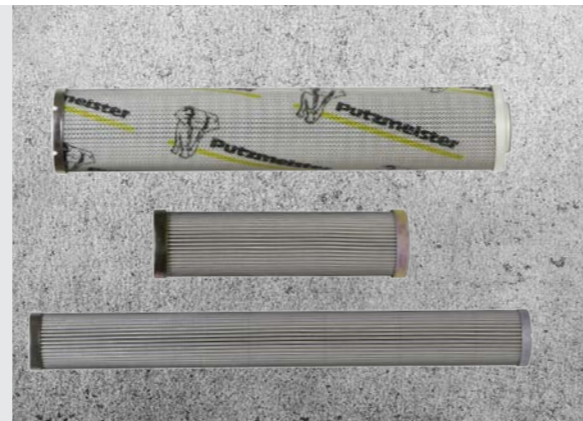

## Excellent in quality customer proximity

In case of need, you have two options: Either the service team visits you or you take your machine to one of our service workshops. The latest tools, software analysis solutions and genuine parts ensure that your machine is operable again immediately.

All Putzmeister workshops and the workshops of our international Putzmeister partners meet our high quality standard. Especially when it comes to manufacturer's inspections and acceptance procedures in accordance with specifications.



## Induction at handover – everything correct from the outset

So you and your machinist can adapt perfectly to all special features and innovations.

## Customer training – benefit from expert knowledge

Practice-based learning offers a host of benefits: Your employees master the machine with all its special features, use the machine to optimum effect, reduce operating costs and avoid operating errors.

## 100 hours of customer service – avoid potential sources of error

Our customer service team provides you with a status report on your concrete pump as per the Putzmeister service plan.

## Our services for cost-effective activities

The Putzmeister service support points offer you these services – all provided by our experienced service employees:

## Mandatory machine inspection – calculable costs instead of incalculable failures

Visual inspection and functional check of components for 100% safety. The hydraulic system with cylinders, electrical system and core pump are also inspected.

## 500 hours of customer service – protect your investment, retain your value

Our technical customer service team is the number one choice for checking the safety and wear of your machine. You receive a status report for this too.

## Our range of training courses and seminars

### For concrete pump machinists

- Training and development seminars Concrete pumps
- Training and development seminars PUMI with piston and rotor pumps
- Regional / company seminars (in your region or on your premises)

### For concrete pumps mechanics

- Training and development seminars Concrete pumps

### For concrete pump machinists and mechanics

- Practical days in Aichtal
- Training: Handover and induction, on-the-job training

### For workshop managers and foremen

- Overview of current developments in Putzmeister concrete pumps
- Qualification at the customer workshops for requisite maintenance work

Further information can be found at: [www.pm-akademie.de](http://www.pm-akademie.de)





# The 53-6, 54-5 and 56-5 at a glance

- **Smooth 5-arm placing boom** thanks to intelligent laying of the delivery line and the balanced development of the steel structure
- **High flexibility and more range for high ceiling concreting** provided by the six-arm placing boom (53-6 only)
- **Efficient work** through consistently clever ergonomic design
- **Maximum safety** through closer consideration for current standards and guidelines
- **Service-friendly** as a result of its optimised accessibility and consistent bolted concept
- **Minimum service costs** thanks to maintenance-free components
- **High load possibility** on the tip of the boom of 200 kg (only 54-5)
- **Use of a 4 m end hose** with squeeze valve or a separated end hose possible (only 54-5)



Concrete pump  
53-6



Concrete pump  
54-5



Concrete pump  
56-5

Please note: The figures in the brochure may differ from the series scope of the machines.  
Further brochures: Ergonic® CT 4690



## Putzmeister Concrete Pumps GmbH

Max-Eyth-Straße 10 · 72631 Aichtal / Germany  
P.O.Box 2152 · 72629 Aichtal / Germany  
Tel. +49 (7127) 599-0 · Fax +49 (7127) 599-520  
pmw@pmw.de · www.putzmeister.com



Putzmeister Concrete Pumps GmbH | P.O. Box 2152 | 72629 Aichtal | Tel. +98 224 286 75-8 | Fax +98 224 228 78 | +98 0912 8 584 584 kormit.abedi@yahoo.com Right to make amendments reserved | © by Putzmeister | All rights reserved | Printed in Germany | 1707  
www.saghargostar-co.ir